

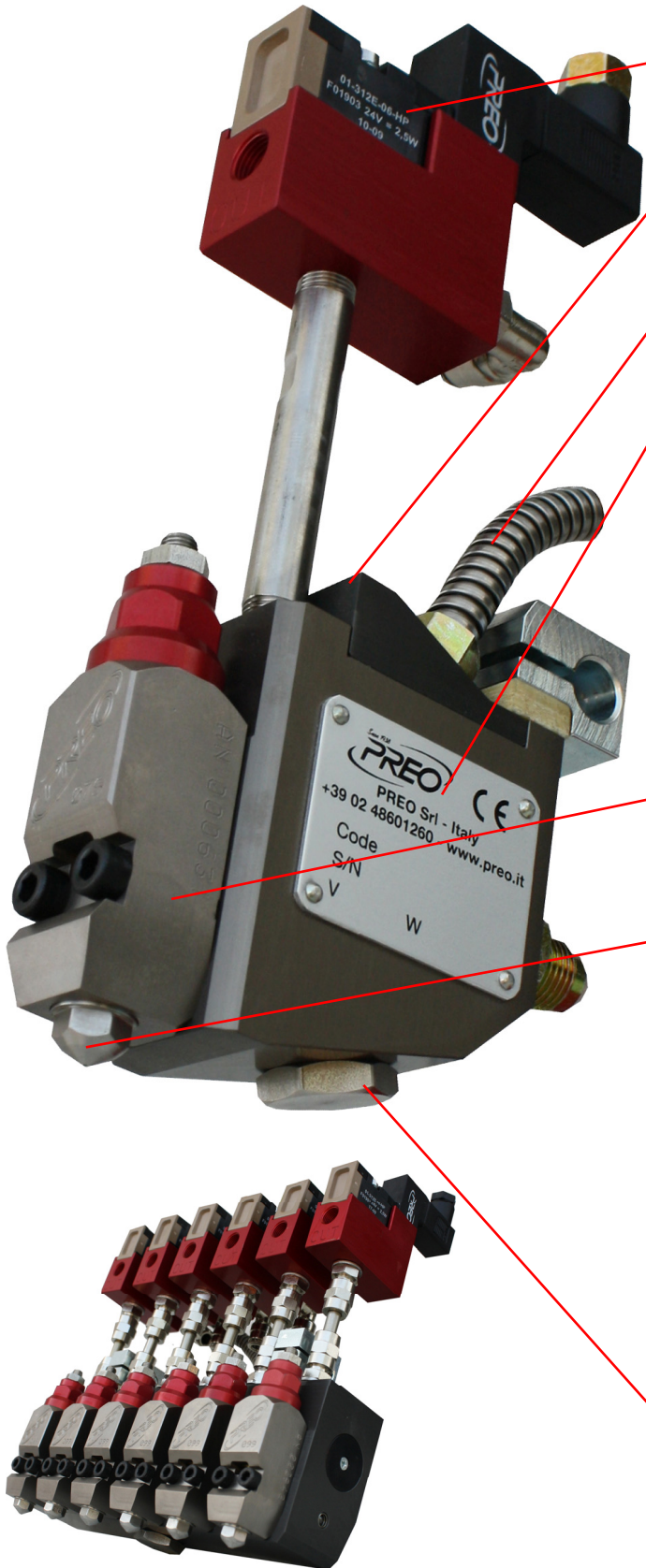

NEW LIFE series glue guns are built with standard or high-temperature configurations, with one or more modules with different types of centre diameters and nozzles, and with one or more solenoid valves, in order to satisfy the widest range of different requirements. NEW LIFE's main features are: speeds up to 6.000 cycles/minute, AMX 45 module with double interchangeable gasket cartridge, Zero-Cavity self-cleaning nozzle, protective non-stick casing coating, integrated glue filter which is removable without disassembling the hose. This wide, complete range of different models makes it possible for even most demanding Customer to find the best solutions for any gluing needs.



SOLENOID VALVES

In addition to standard solenoid valves, Preo has developed a new model that is ranked at the top of the market offer. Depending on the required applications, this valve can deliver the highest level solution for tasks that require low energy consumption, high-speed application, small size and weight.

GUN CASING

The casing is built in "Ergal", an aluminium alloy that considerably improves the product's resistance to mechanical stress. The hard oxide cover makes gun cleaning and maintenance quick and easy.

ELECTRICAL CONNECTIONS

Removing the electrical kit is easy, simple and safe.

THERMAL-HEATING

The gun is heated with highly reliable heating coils controlled by extremely precise sensors.

AMX 45 MODULE

All guns are equipped with a new AMX 45 Series module that ensures precise, regulated glue application. This level of performance was possible only because of the special attention dedicated during the design and construction phases. The most important aspect of the AMX 45 module is its innovative gasket system with the double interchangeable cartridge, which guarantees a perfect seal at high pressures and temperatures in addition to simple, inexpensive, and long-lasting maintenance.

NOZZLE

The gun is supplied with stainless steel Zero-Cavity self-cleaning nozzles, available with a minimum diameter of 0.25 mm to a maximum of 1.2 mm. Zero-Cavity is the term used for the cut-off that directly closes the nozzle hole, eliminating any possible impurities and guaranteeing the constant cleanliness of the nozzle. This guarantees that the system always works properly. The wide range of nozzles includes a number of configurations and special designs, based on the Customer's needs. Preo nozzles stand apart from the competition due to their basic technical features, which can be summarized as follows. First: the nozzles are made of durable materials with the highest level of resistance to wear and tear. Second: their thermal conductivity is much greater than the traditional steel, with the advantage of quick heat transmission, at least 8 times higher than normal. Third: concerns the construction geometry, due the fact that multi-way nozzles ensure the same reliability as the traditional Zero Cavity nozzles.

GLUE FILTER

This guarantees better distribution of the glue and prevents nozzles from clogging due to the presence of impurities in the glue. The filter is integrated into the casing, and is easily accessible and can be quickly replaced without disassembling the hose.

TECHNICAL SPECIFICATIONS

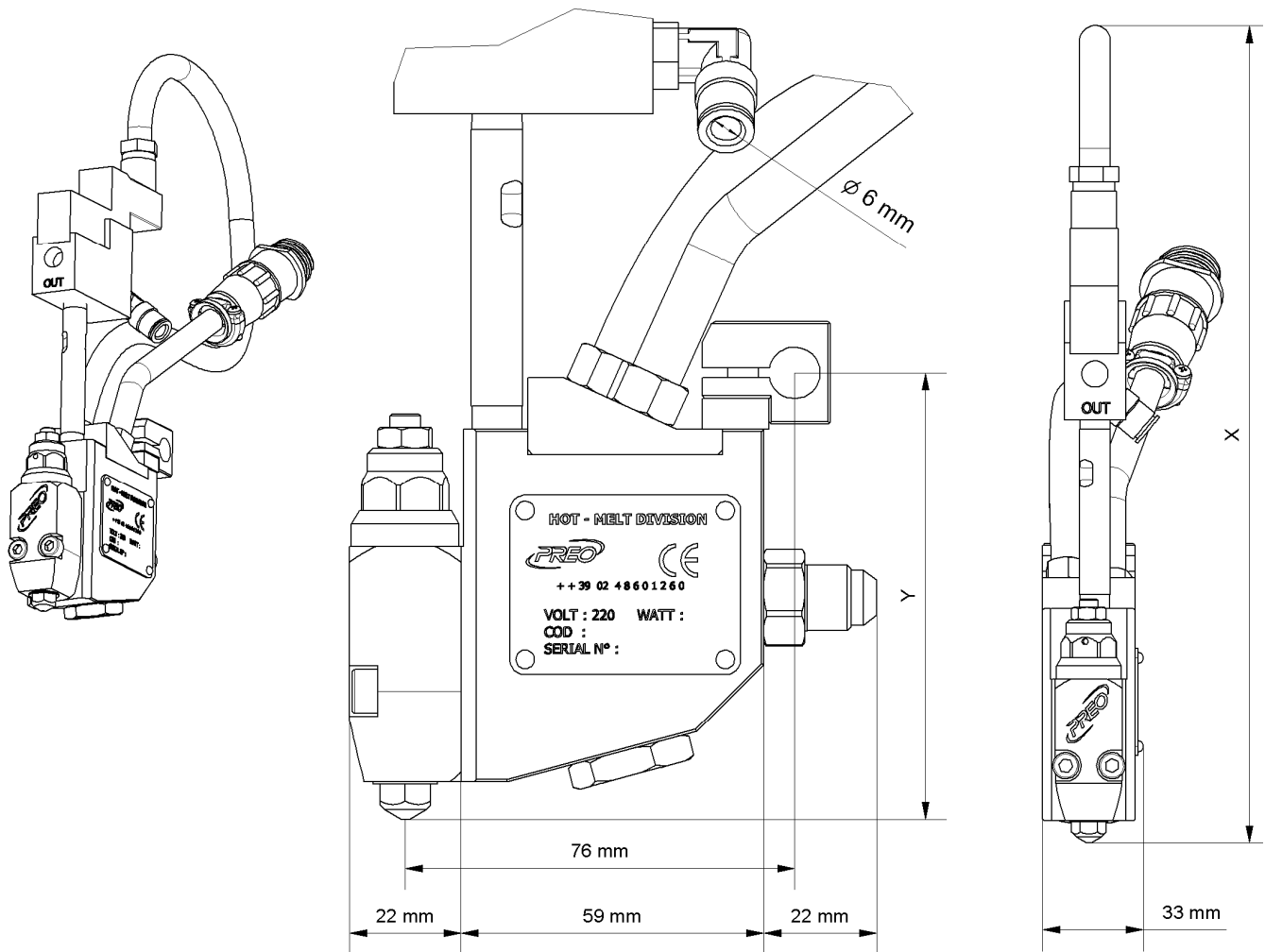

GENERAL SPECIFICATIONS

VERSION	G0SEA01 KV	G0SEA01 LV	G0SEA01 NDS	G0SEA01 MVN	G0SEA01 XLV
DIMENSION (x)	280 mm	297 mm	294 mm	293 mm	345 mm
DIMENSION (y)	87 mm	104 mm	97 mm	100 mm	152 mm
WEIGHT	900 gr (2 lb)	900 gr (2 lb)	900 gr (2 lb)	900 gr (2 lb)	1000 gr (2 lb)
FASTENING	mounting bracket with hole diameter mm 10-12-12,7-14				
ADHESIVE TYPOLOGY AND VISCOSITY	hot-melt up to 100.000 Cps				
OPERATING TEMPERATURE	50°C±210°C (120°F±410°F) standard version - 50°C±230°C (120°F±450°F) HT high temperature version				
TEMPERATURE CONTROL	PT100 ±0,5°C (1°F) - RTD or Ni120 (on request)				
HEATING	cartridge element				
GUN BODY	coated with hard oxidation treatment and glue filter integrated				
NOZZLES	1-2-3-4 ways with minimum diameter 0,25 mm				

ELECTRICAL SPECIFICATIONS

VOLTAGE	1/N/PE AC 230 V ±10% 50/60 Hz
POWER CONSUMPTION	180 W (0,8 A)

PNEUMATIC SPECIFICATIONS

MAXIMUM CYCLE RATE	6000 cycles/minute
WORKING PRESSURE	6 bar
SOLENOID VALVE WATTAGE	2,5÷17,1 W
SOLENOID VALVE VOLTAGE	24 V (special voltages on request)
MAXIMUM WORKING PRESSURE	55 bar

© Copyright 2011 PREO SRL - All rights reserved - Subject to change without advanced notice - Printed in Italy - Edition EN-501 NEW LIFE GUNS - 14/09/2011

PREO S.r.l.

Via Alessandro Volta, 7 • 20094 Corsico (MI) • Italia
 tel. (+39) 02 48601260 • fax (+39) 02 4503323
 www.preo.it • italia@preo.it • world@preo.it